



www.MPI-Ultrasonics.com

MMM ULTRASONIC PROCESSING

(Multi-frequency, Multimode, Modulated Sonic & Ultrasonic Technology)

Brand new solids and liquids processing solutions in various segments including Food Industry, Pharma, Offshore, Oil & Gas, Energy production, Mining, Environmental and General Industry markets.

FIELDS OF APPLICATIONS

- *Internal descaling, deposits-removal and cleaning without stopping technological process,*
- *Fluid flow acceleration, chemical and petrochemical technologies optimization,*
- *Internal cleaning of heat exchangers, nuclear and electric power plant reactors, without stopping the process, with significantly increased time between two maintenances.*

MMM Technology Introduction

- Through comprehensive and unrivalled understanding in ultrasound wave formation, its coupling to mechanical systems, and its optimization through finite element analysis, MPI has the ability to provide solutions which are not yet possible with state of the art technology. MMM Technology cleans heat exchangers continuously and during operation using ultrasound. MMM Ultrasonic transducers are attached to the tube-sheet of shell and tube exchangers. High frequency, low displacement vibrations prevent mineral scale and fouling build-up from settling, which improves heat transfer efficiency and significantly lowers operational-energy costs.

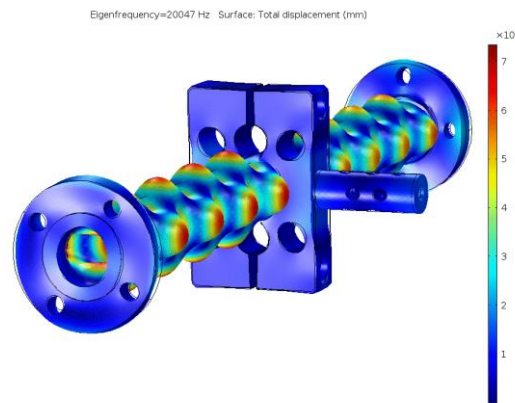
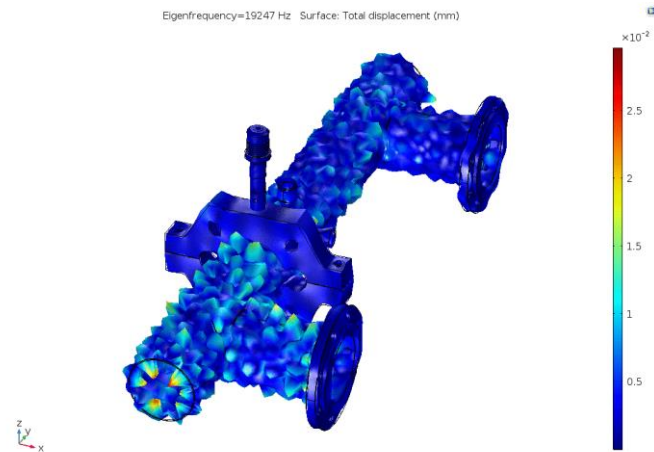

MMM Technology In Action

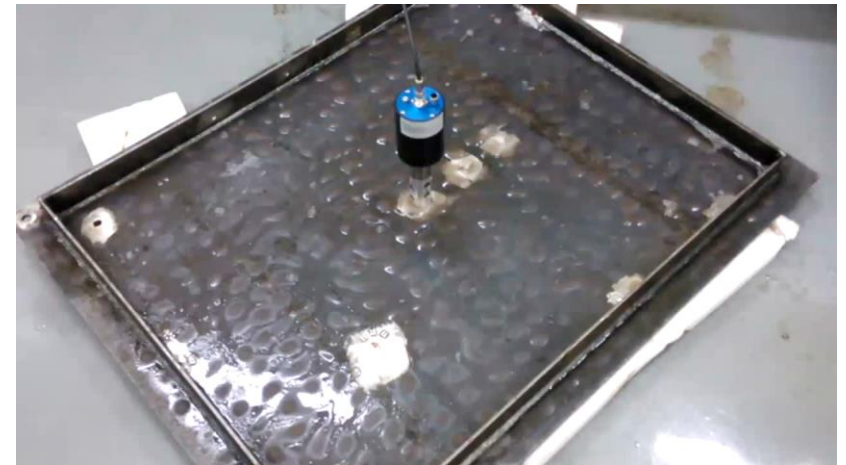
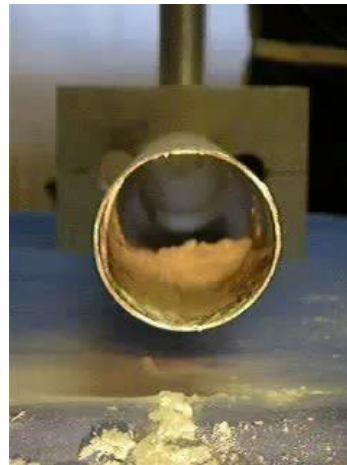

MMM Technology Application Methods

Fixed Actuator System (for large parts)

- The “future” advantage in the MMM technology is that it can be used for heat exchangers preventive maintenance, descaling and continuous in-line cleaning, as well as for stress relief without stopping industrial processes.
- Small number of strategically placed and fixed actuators will de-stress in minutes (less than 30min)
- One Generator / Actuator system can be re-applied for a variety of “large” assets
- Generator / Actuator can simply be adjusted to fit a specific assets residual stress relief requirements



MMM Technology Applications

(see video animations below)

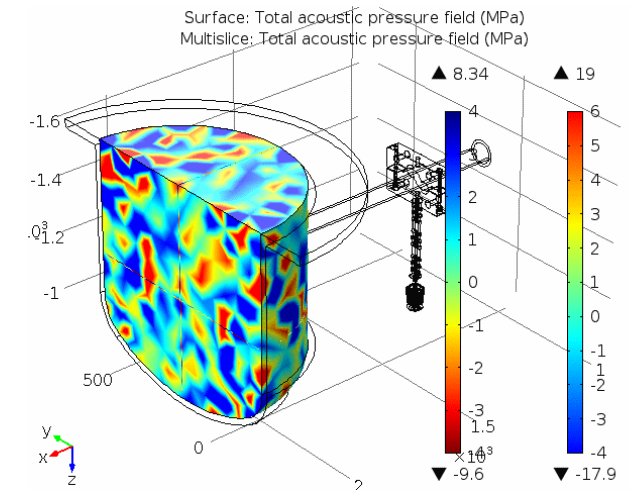
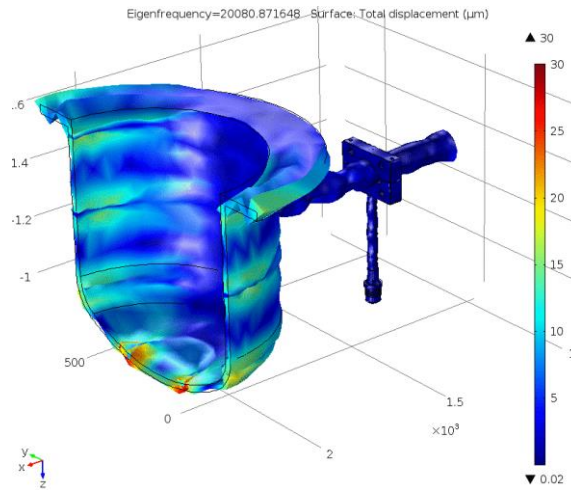
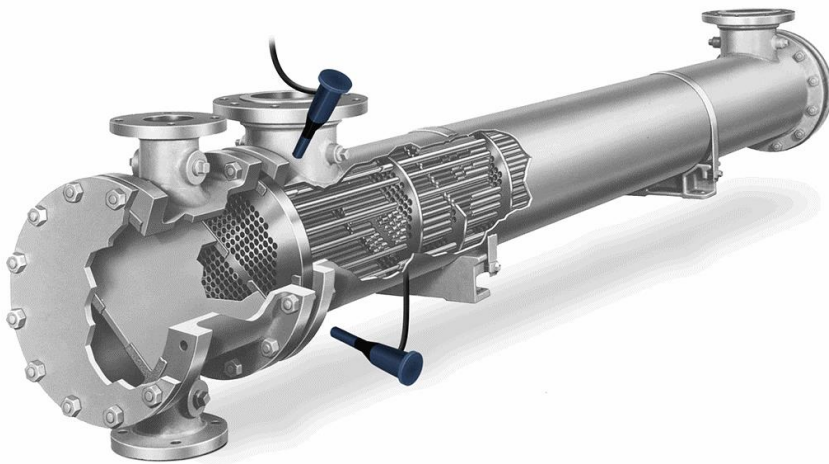
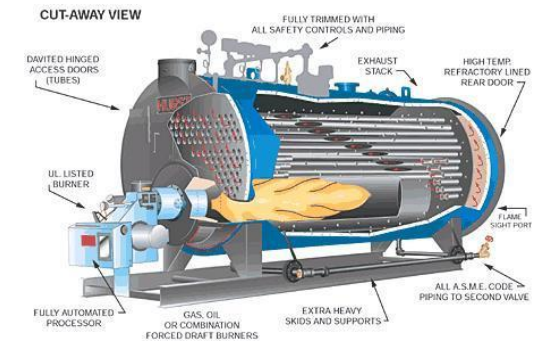

Benefits

- The overarching benefit of MMM Ultrasonic Technology is the extended run-length you'll achieve —Here's how.
- [MMM Technology](#) is a Clean-in-Place (CIP) system that works 24/7, during full-process operation. USP uses calibrated ultrasound to mitigate the formation and adherence of fouling and scale deposits from settling on heat transfer surfaces. This continuous cleaning mechanism leads to multiple processing benefits.
- **UNIT PROFITABILITY**
- The production losses due to cleaning-related downtime, whether shutdown or turnaround, can cost a facility far more than outage activities themselves. Conventional methods like hydro-blasting or chemical circulation always require unit downtime. They cannot guarantee optimal heat exchanger performance through the run.
- [MMM Technology allows your process to work in full operation as continuous cleaning takes place. Some processing organizations have been able to skip multiple-cleaning outages by leveraging Ultrasonic Clean-In-Place.](#)
- **HEAT TRANSFER**
- Fouling reduces the amount of heat recovered from product streams. More heat must be supplied by the furnace/heat source to compensate for the lower feed temperature. Operating costs can increase by up to 6%¹ from increased fuel consumption.
- **MMM Technology** increases turbulent flow and sustains surface cleanliness, allowing for better heat transfer. [A refinery who implemented our Ultrasonic CIP system](#) reported OHTC levels similar to when this heat train was first put into service, 5 years previous.
- **FURNACE DUTY**
- Fouling in heat exchangers will reduce the productive diameter through which heat exchangers are able to operate. Throughput limits include hydraulic pressure or duty constraints. Common procedures for restoring some throughput, are either online spalling of the tubes or by incurring a production shut down to clean the assets.
- **MMM Technology** disrupts scale and fouling deposition every hour of the day. The ultrasound keeps transfer surfaces clean for longer— improving pump, furnace and fuel efficiencies.

Benefits

- **UNIT DOWNTIME**

- **Cleaning a heat exchanger (Hx) can involve 20+ activities:** unit bypass, depressurizing, in-situ pre-clean treatments, scaffold assembly, Hx disassembly, crane, bundle extraction, transporting to a cleaning area, cleaning contractor, water, chemicals and of course the remediation of the water, chemical and waste products. This process nearly repeats in reverse for putting an exchanger back into service. Each step involves multiple contractors, permits, meetings, reports, and potential delays.
- As **MMM Technology** continuously mitigates fouling during full operation, processors need not shut down as frequently to clean. Sure, maintenance cost savings can be a significant benefit. However, it's only a fraction of the financial benefit when compared to the margin gained on potential process throughput had you not shut down at all.

- **CO2 EMISSIONS**

- Having to open heat exchangers for cleaning, the cleaning methods and chemicals themselves, all share in the reliability, safety, and environmental risks. Hundreds of our colleagues are injured each year in cleaning. It's estimated that 1-2.5% of global CO₂ emissions come from heat exchanger fouling and cleaning. That's significant.
- **MMM Technology** helps to reduce these figures by keeping the heat exchangers cleaner, for longer intervals. Cleaner exchangers require less fuel to operate. Less fuel and less cleaning is good for all of us.

ANYTHING CAN BE ULTRASONICALLY VIBRATED FOR:

**Cleaning – Descaling - Deposits Removal – Fluid Flow Acceleration – Chemical Processing optimization
Fast Stress Relief - Fatigue Life Extension - Mitigation of Stress Corrosion**

see video files below:

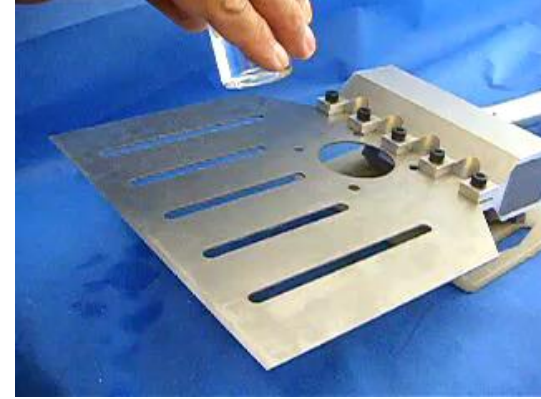

MMM technology in the future

Redefining Ultrasonics:

In traditional ultrasonic technology, transducers are designed to satisfy pre-defined and fixed resonant conditions. Each and every “simple and regular shaped” object under consideration for ultrasonic processing in general has its own particular natural frequency.

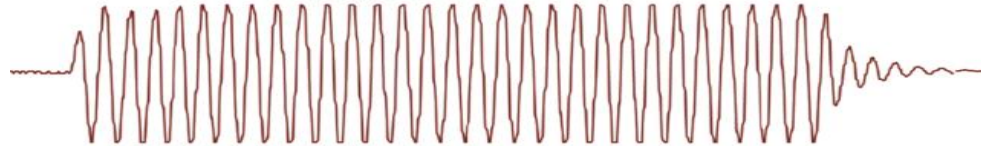

In contrast MPI has developed the proprietary Multifrequency, Multimode, Modulated Sonic & Ultrasonic system.

(MMM) This system generates multimode mechanical oscillations in any (large, small, complex) mechanical body over a very wide frequency range.

This avoids the creation of stationary or standing waves, typically produced by traditional ultrasonic systems. MMM technology provides much greater freedom of control, regulation and programming over all vibration, frequency and power parameters.

However, when the object becomes larger and more complex (e.g. larger, arbitrary shaped objects or structures) then the more complex and diverse the natural frequencies become.

Therefore, in order for traditional ultrasonic technology to achieve a maximal efficiency, all bodies being oscillated must resonate at the same frequency and have the exact same natural frequency throughout the object. This is not the case.

How it works

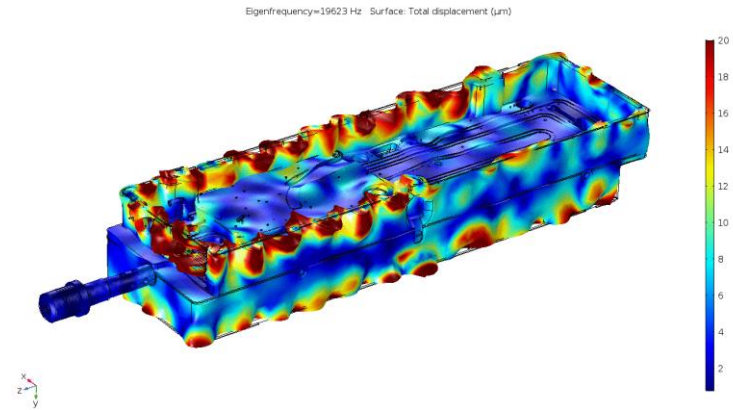
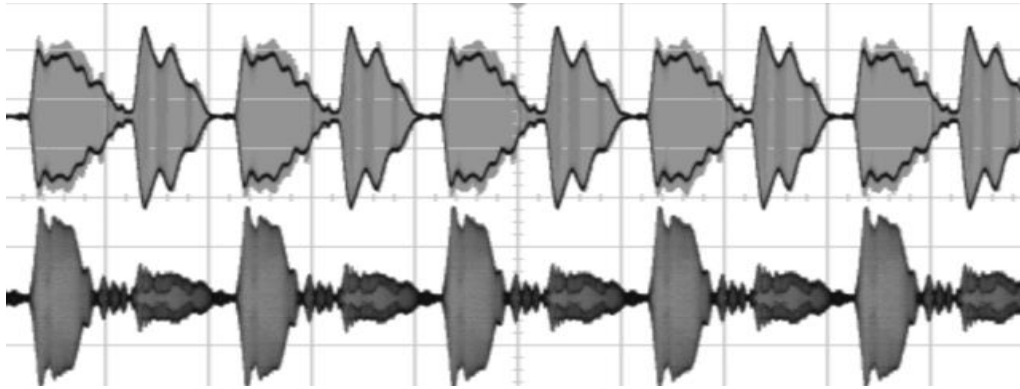

Complete and homogenous agitation of large bodies of liquids
Complete resonance throughout any small, large and arbitrary shaped object
Production of long range and long-lasting cavitation / micro-cavitation in liquids
Ability to customize ultrasonic effects in solids and liquids by

Subsequent Application Fields

The Resulting Innovation:

All traditional sonic and ultrasonic actuators or transducers available on the market today oscillate in a relatively simple constant-frequency, contraction-extension vibration mode.

Such “traditional” technology can be applied for treatment of relatively simple and regular shaped objects which tend to have their own particular natural frequency. However, when the object becomes larger and/or more complex then, the more complex and diverse the natural frequencies become.

Subsequent Application Fields:

The patented MPI Solutions "Multi-frequency, Multimode, Modulated Sonic & Ultrasonic" actuators operate at certain pre-defined and optimal resonant frequencies. The result is a completely uniform and well distributed vibrational agitation. This, in combination with a continuously applied frequency and amplitude modulation, agitates or excites many resonant modes, harmonics and subharmonics of any large or complex object which is very beneficial for a large number of applications and technologies.

- Stress Relief in small and large objects such as, Watch Industry, Bridges, Platforms, Steel Structures.
- Fluid Processing for liquid alloys, Nano Particle Production, Micro Crystallization, Solid / Liquid Separation.
- Long Range Micro Bubble and Cavitation for Algae Growth Prevention, Biofilm Prevention, In-line Scale / Fouling Prevention.
- Improvement of Electro-Chemical Efficiency for Electro-Chemical, Energy Storage, Solar Energy Production.
- Ultrasonically assisted Metal Machining for Milling, Drilling, Polishing etc.

Wide-band sonic and ultrasonic energy (ranging in frequency from infrasonic up to the MHz domain) propagates through arbitrary shaped solid structures, heavy and very-thick-walls metal containers, pressurized reservoirs, very thick metal walls of autoclaves, etc. in many different mechanical structures.

The uniqueness in MMM is its novel and patented sonic / ultrasonic, multifrequency power supply (MMM Technology) that can initiate ringing and relaxing, modulated, multimode mechanical oscillations including harmonics and sub-harmonics.

Whether using MMM through a Peening tool or through Fixed Actuators (for large parts), the technology can allow for deep metal penetration (factor 2 to 4 of competitor technology) and long range effects of more than 10 meters (for fixed actuators). The vibrations caused are not standing waves but are "chained together" to facilitate the long-range effect (patented MMM)